



Bruggan
premium decking

INNOVATIVE
TERRACE SYSTEM

Bruggan

17 YEARS
IN BUSINESS

620 000 M² TOTAL AREA OF
OUR PROJECTS

75 000 PRESERVED TREES

100% ENVIRONMENTAL FRIENDLINESS

THE BEST OF TWO SPHERES

Bruggan is not just a company. We are a team of professionals whose mission is to create environmentally friendly and durable materials that will preserve forests for future generations.

We have combined innovative ideas, team experience and high-quality materials.

As a result we have created a unique Bruggan Multicolor decking plank, the structure and texture are entirely identical to natural wood, making it a true breakthrough in the industry.

We believe that nature is the best source of inspiration, so we strive to preserve it in its original form and create such products that align to this mission.

We guarantee that Bruggan decking planks will bring you joy and comfort. It is a reliable and environmentally friendly solution for your home.



02



ADVANTAGES OF BRUGGAN COMPOSITE PLANKS OVER NATURAL WOOD:

DURABILITY:

Natural wood is destroyed by the natural change of weather cycles: humidity, solar radiation, fluctuations of ambient temperature. Bruggan is not susceptible to such corrosion due to its composition.



RESISTANCE TO DEFORMATION:

Bruggan has a stable geometry and, unlike natural wood, does not crack due to contraction or shrinkage of the material.

MAINTENANCE:

To maintain the aesthetic appearance, natural wood requires regular treatment with special agents. WPC does not require such maintenance, which saves time and money.





ECO-FRIENDLINESS:

To protect natural wood from mold and harmful insects, it needs to be treated with aggressive solutions and regularly coated with varnish or paint. Bruggan does not require any additional chemical protection, making it eco-friendly and safe for human health and the environment.

TREE FELLING IS NOT REQUIRED

The use of WPC materials reduces tree felling, which in turn contributes to the preservation of forests and nature in general.

WHAT SETS A BRUGGAN PLANK APART FROM 80% OF OTHER WPC DECKING TYPES?

-  Visually and to the touch, the WPC repeats the wood structure
-  Unique manufacturing technology
-  Made from 60% hardwood flour
-  25 years warranty for solid boards and 15 years warranty for hollow boards

THE SURFACE LOOKS AND FEELS WHEN TOUCHED LIKE NATURAL WOOD

- Annual ring pattern throughout the material's thickness
- Unique pattern and shade on each plank
- Embossed texture is like on a wood coating

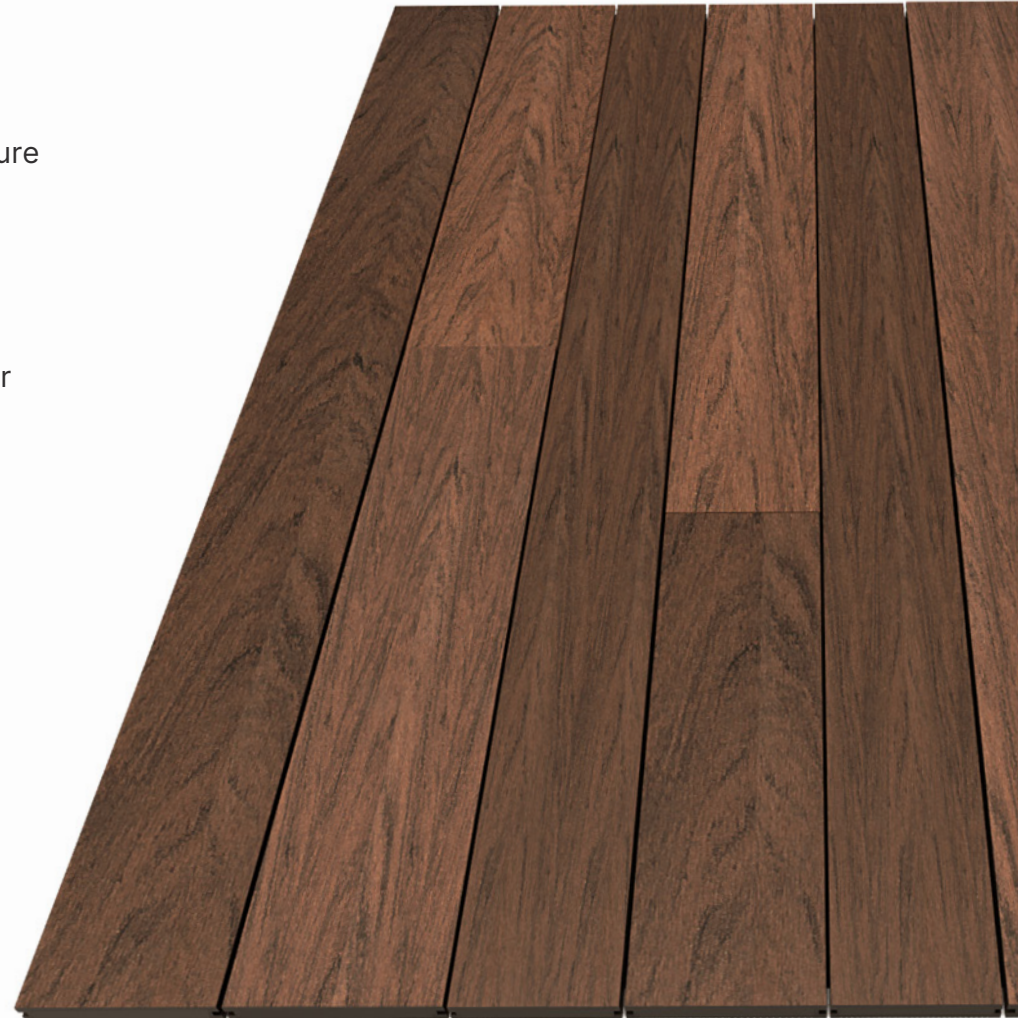

PREMIUM WOOD SELECTION.

WOOD FIBER LENGTH.

Our technologists have developed a fiber length standard that allows for maximum material reinforcement. This makes it durable and elastic and helps withstand higher loads.

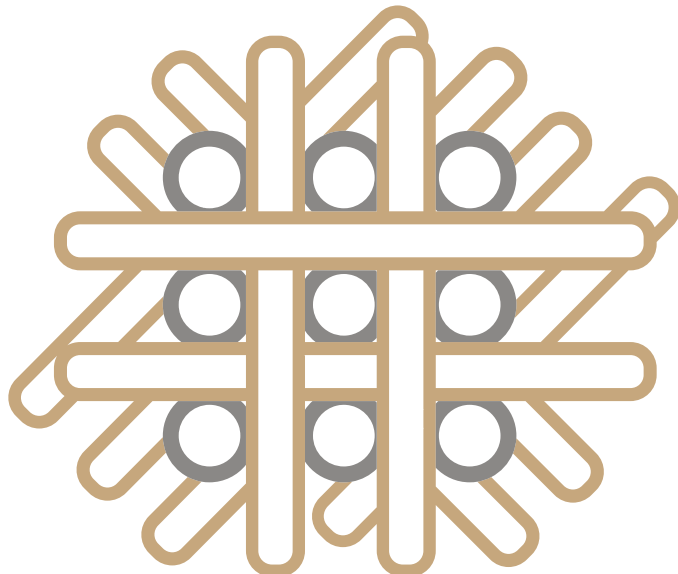

HARDWOOD FLOUR

Bruggan products are exclusively made from hardwood such as beech and oak.

80% of wood-polymer composite manufacturers use such softwoods like pine and spruce due to availability and low cost.

Such wood has low density and contains a large amount of resins, significantly reducing plank durability and causing oily stains form on its surface.

MOISTURE OF THE FLOUR

Moisture level is a crucial aspect of quality.

During WPC manufacturing, excess moisture in the wood flour makes the material loose, significantly increasing moisture absorption and reducing density.

BRUGGAN PLANKS DO NOT CONTAIN PVC

- Only safe polymer
From food and cosmetics packaging. We do not use containers from industrial chemicals and medicines.
- We use polymer of primary processing.
This allows us to preserve its density and control the origin.
- We apply polyethylene
Our planks contain no PVC, which means they do not emit formaldehyde, carcinogens, and heavy metals even when burned.

COMPOSITION 60% WOOD FLOUR

- Bruggan planks use exclusively recycled wood, no trees cut.
No softwood or pine flour is used; only hardwood flour is capable of achieving the required plank strength.
- Strictest control of fiber length and moisture level.

PREMIUM QUALITY ADDITIVES SELECTED

- Provides UV protection and ensures strong wood-polymer bonding, determining the material's quality, resistance to external factors, and durability.
- Bruggan planks are manufactured using additives exclusively from top global brands.
- Each additive comes with a safety data sheet, ensuring quality and safeguarding against adverse effects on health and the environment.



06



PRODUCTION



HIGH QUALITY STANDARDS

We place great importance on the quality of our products, as we care about the safety and comfort of our customers.

Therefore, when manufacturing Bruggan decking planks, we implement a multi-level laboratory control, which includes testing the raw materials - wood flour, polymers, additives - to meet high quality standards.

We conduct thorough strength and density checks on the finished products using advanced technologies. Additionally, to ensure the durability of Bruggan terrace boards, we subject the final products to tests for weather resistance and external impacts.

Our comprehensive approach to quality control encompasses all necessary processes, ensuring the reliability and safety of our products.

BRUGGAN PRODUCTS

are backed by European certification, ensuring their exceptional quality, and are suitable for construction in both residential and industrial settings.



08

INNOVATIVE
WOOD

BRUGGAN MULTICOLOR

Being the first to achieve the imitation of annual growth rings, Bruggan decking not only boasts an almost identical wood appearance but also offers the versatility of being fully utilized just like natural wood - it can be cut, sanded, and treated.

Experience the warmth of the wood beneath your feet as you walk barefoot across the Bruggan floor planks

INNOVATION

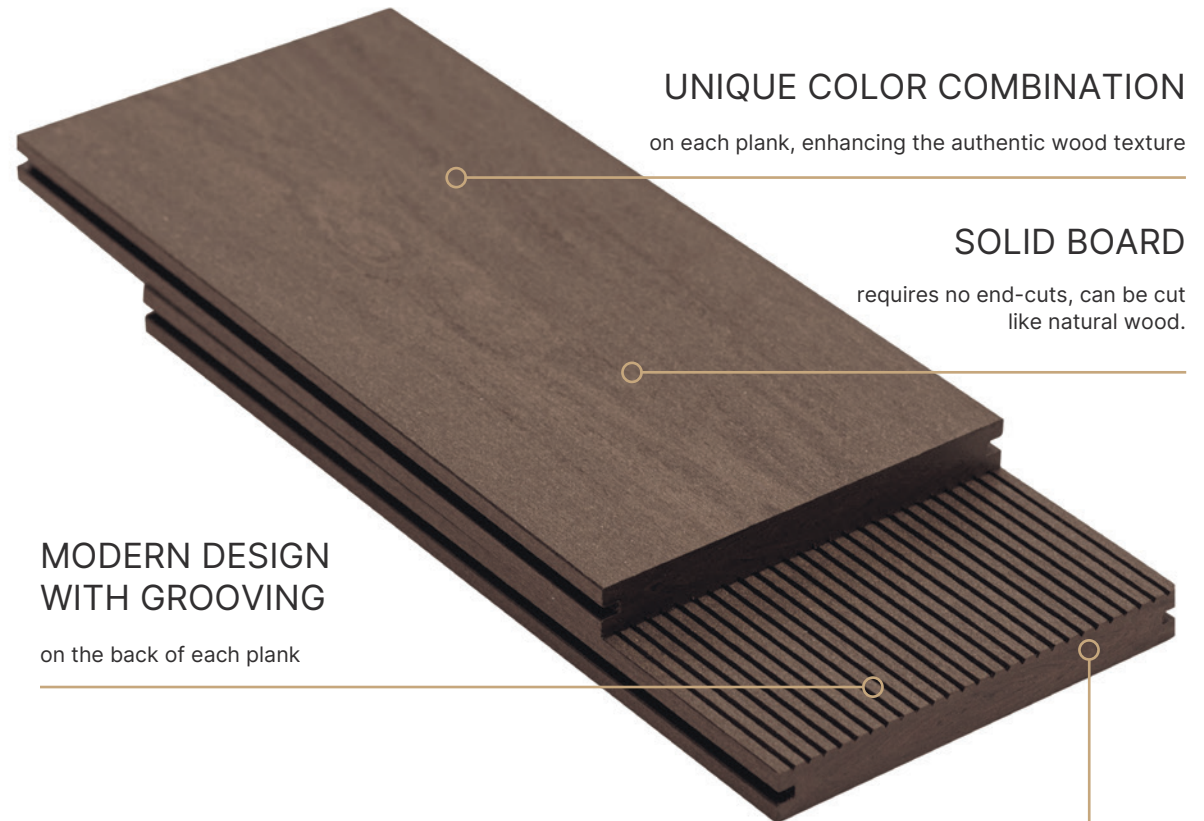

UNIQUE COLOR COMBINATION

on each plank, enhancing the authentic wood texture

SOLID BOARD

requires no end-cuts, can be cut like natural wood.

MODERN DESIGN WITH GROOVING

on the back of each plank

WOOD GRAIN FOR COMPLETE THICKNESS

Imitation of "annual growth rings" on the edge



BRUGGAN MULTICOLOR TERRACE PLANKS

HAVE A RENEWABLE SURFACE

Bruggan Multicolor floor planks feature a renewable surface, allowing for easy removal of scratches or stains using standard sandpaper.

Even after years of daily use, the terrace maintains a new-like appearance, making Bruggan planks ideal for parks, cafes, and other high-traffic areas.

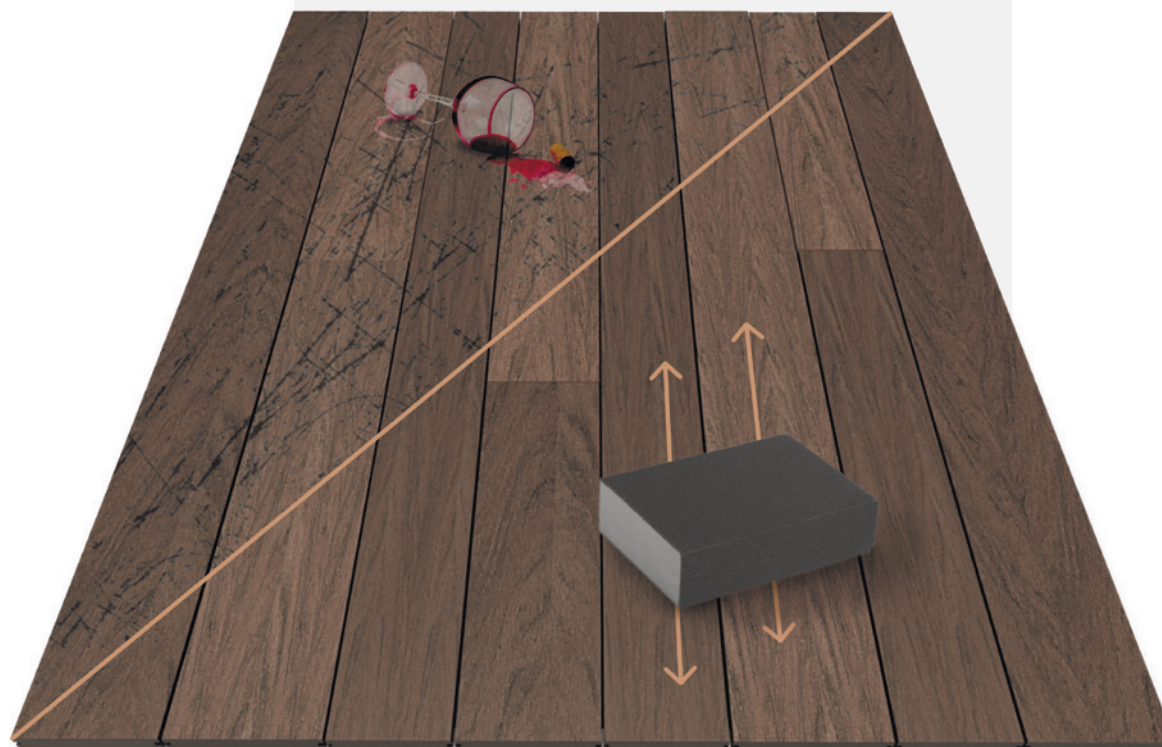

BASIC COLLECTION

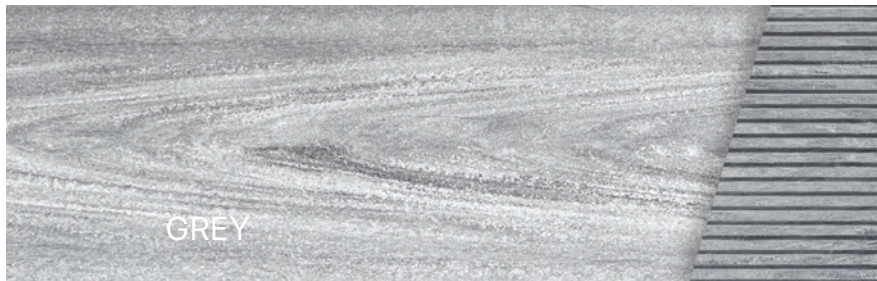

NEW COLOR



BRUGGAN MULTICOLOR

The solid board offers enhanced strength while mirroring the look and feel of natural wood. Its operational and decorative qualities surpass those of even elite wood types.

Premium quality environmental-friendly material.

SCOPE OF APPLICATION

Terraces for residential buildings and commercial premises
Parks areas
Piers, docks
Stairs
Gates

ADVANTAGES

Wood texture throughout the material's thickness
Ecological-friendly and safe
Increased strength
Ideal for radius cutting

EQUIPMENT



PROFILE

120x19x3000 mm
140x19x3000 mm
160x19x3000 mm



CORNER

40x40x3000 mm



BRUGGAN REINFORCED SUPPORT

53x43x3000 mm



STANDARD SUPPORT

40x30x2200 mm



BRUGGAN REINFORCED LOAD-BEARING SUPPORT

53x43x3000 mm



FIXING CLAMP

Stainless steel 304



STARTING CLAMP

Stainless steel 304



RETAINING CLAMP

Stainless steel 304



SMOKE WHITE

Smoke White is an exquisite and elegant shade in the Bruggan Multicolor decking palette. It is ideal for those who want peace and quiet on their terrace. The combination of milk and gray tones gives it uniqueness and allows it to harmonize well with both classic and modern styles. It creates a clean and bright space that attracts attention and gives a sense of openness. Due to its light colour, the planks heat up less in the sun, making them an ideal choice for those who like to walk

That is why Smoke White is often used around swimming pools and in SPA areas.

NEW COLOR



INSPIRATION



SAND

Sand is a new color in the Bruggan Multicolor decking palette, perfectly complementing beech, oak or teak parquet. A sand-toned patio allows you to harmonize the interior and exterior design of your home so that they complement each other. Sand looks natural and gives the terrace a feeling of coziness and tranquility. Its versatility also allows it to blend seamlessly with warm and cool colors enabling you to experiment with furniture, textiles, and plants. Create your perfect patio with Bruggan Multicolor Sand.



NEW COLOR



INSPIRATION



FRENCH DECK

TERRACE PLANKS INSTALLATION IN THREE WIDTH OPTIONS ON A TERRACE

This is a global trend that seamlessly complements almost any exterior, adding a vintage style to your floor. Vintage is an era recreated anew.

For those who have dreamed of their own unique and charming outdoor space, the French Deck offers a timeless and captivating solution.

With this type of terrace plank installation, it stands out not only for its width, which gives the floor covering a special "chic", but also in the "play" of color.

This effect is achieved through a special color technology, in which the color of each plank differs slightly with a subtle shade. In the overall arrangement, the deck looks "luxurious" and natural.

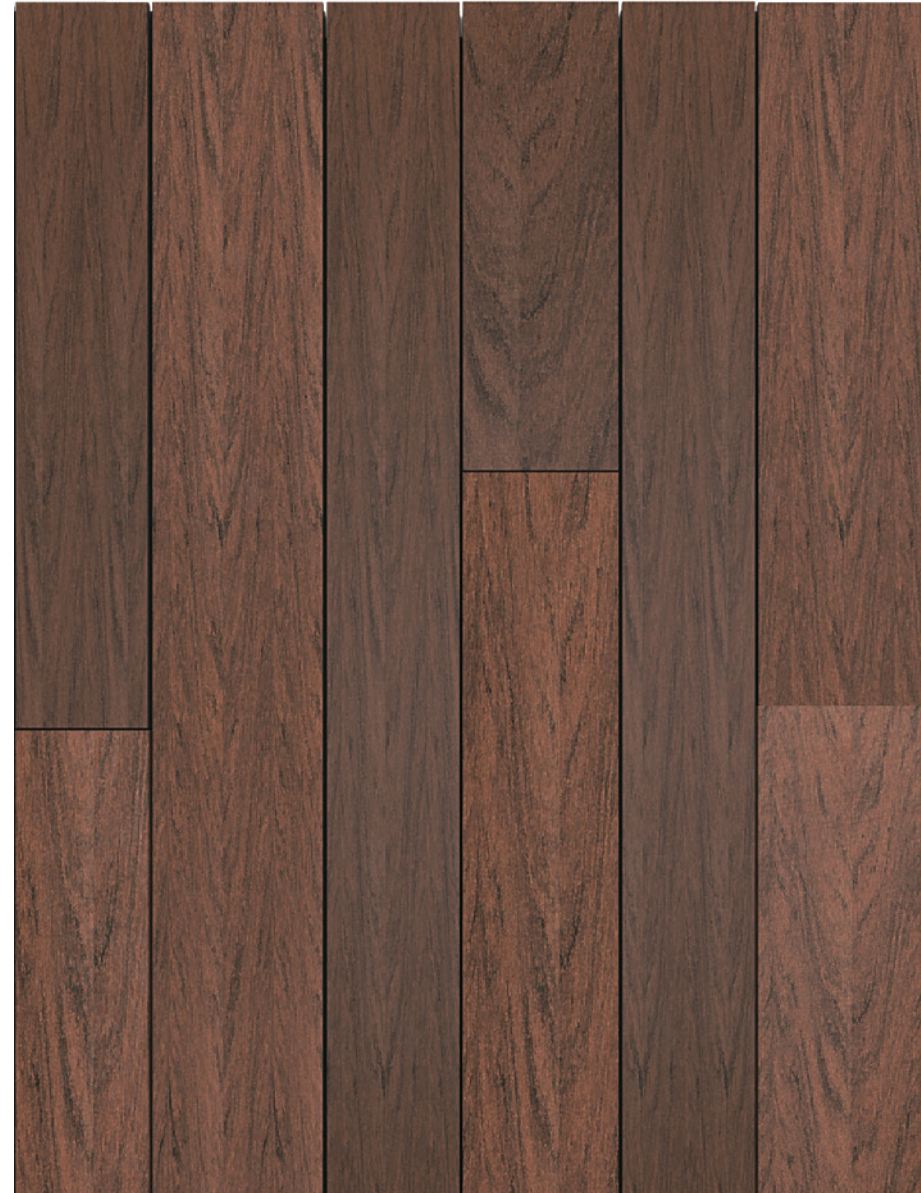
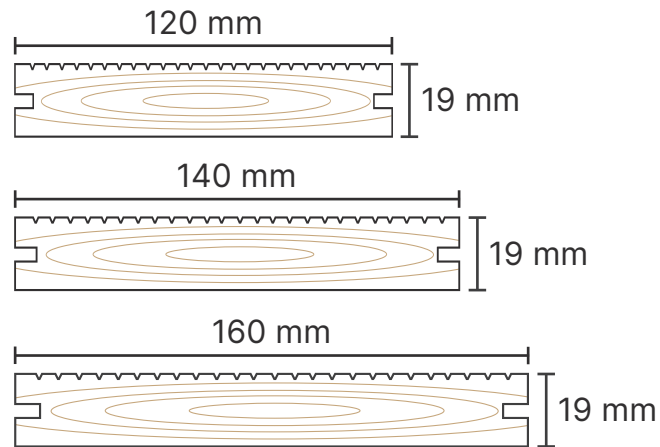

TYPE OF TERRACE PLANKS INSTALLATION

PARAMETERS

16

BRUGGAN ELEGANT LIGHT 3D

UNIQUENESS OF THE
PLANKS

PARAMETERS

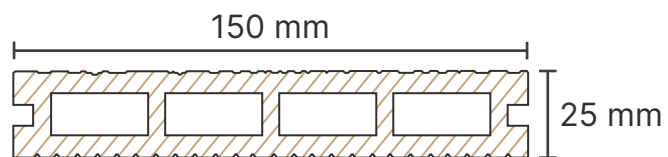

UNIQUE COLOR COMBINATION

on each plank, enhancing the authentic
wood texture

MULTI-TONED STAIN

a blend of different shades, creating the
appearance of natural wood

MODERN DESIGN OF GROOVING

Combination of different shades, creating the
appearance of natural wood

EQUIPMENT



PROFILE
150x25x3000 MM



CORNER
40x40x3000 MM



BRUGGAN REINFORCED SUPPORT
53x43x3000 MM



STANDARD SUPPORT
40x30x2200 MM



BRUGGAN REINFORCED LOAD-BEARING SUPPORT
53x43x3000 MM



FIXING CLAMP
Stainless steel 304



STARTING CLAMP
Stainless steel 304



RETAINING CLAMP
Stainless steel 304



BASIC COLLECTION

18

ANTRACITE

WINE BROWN

GRAPHITE

CREAM LATTE

COPPER NATURAL

NEW COLOR



BRUGGAN ELEGANT LIGHT 3D

Hollow wood-polymer composite board. Deep 3D embossing faithfully replicates the texture of natural wood. Strong, durable, and easy to maintain coating.

Top quality environmental-friendly material.

SCOPE OF APPLICATION

Private terraces
Building facades
Stairs
Gates

ADVANTAGES

Deep 3D embossing
Environmentally friendly and safe
Pleasant to touch
Authentic texture of natural wood



COPPER NATURAL

Updated shade - Copper Natural is warm and natural.

The new shade of Bruggan Elegant decking is softer, lighter and more natural. It is designed to seamlessly complement your indoor flooring, perfect with warm-toned parquet or hardwood. Because it goes perfectly with the warm colors of parquet or parquet floor planks. With Copper Natural you create a unified space for your home, inside and out.

If you prefer quiet classics, this new decking shade is your perfect choice.



20

EQUIPMENT OF THE FLOOR

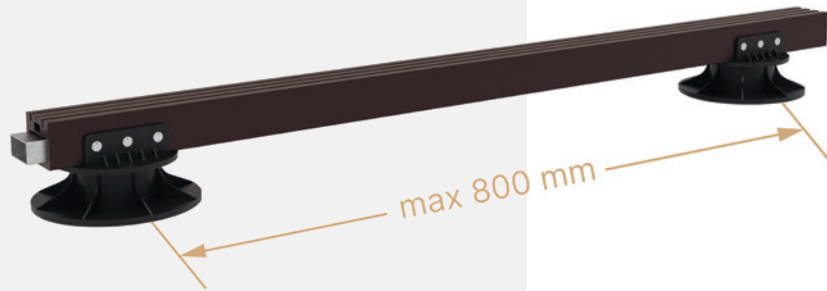

CORE PROTECTED FOR RELIABILITY

An internal aluminum profile is reliably protected from corrosion, destruction, oxidation, deformation and "stray" currents by a composite shell.

LOAD-BEARING JOIST

The double reinforcement allows Bruggan's joist to serve as a load-bearing element, enhancing structural durability and increasing maximum load capacities.

REINFORCED JOIST INCLUDED

Each Bruggan plank comes with a reinforced joist.

NO ADDITIONAL TREATMENT NEEDED

Bruggan's reinforced joist requires no extra treatment throughout its service life, unlike metal counterparts

2 TIMES SAVINGS ON SUPPORTS

Thanks to the reinforced core, the distance between the supports can now be increased from 366 mm to 800 mm.

COMPOSITE AND METAL STRENGTH

The reinforced zinc-coated profile enables Bruggan's composite joist to bear 3 times more load than regular joists.

DOES NOT REQUIRE VIBROTAPE

Bruggan's composite joist evenly distributes loads, dampening vibrations and impacts, unlike aluminum and metal joists.

ADVANTAGES OF THE BRUGGAN REINFORCED JOIST

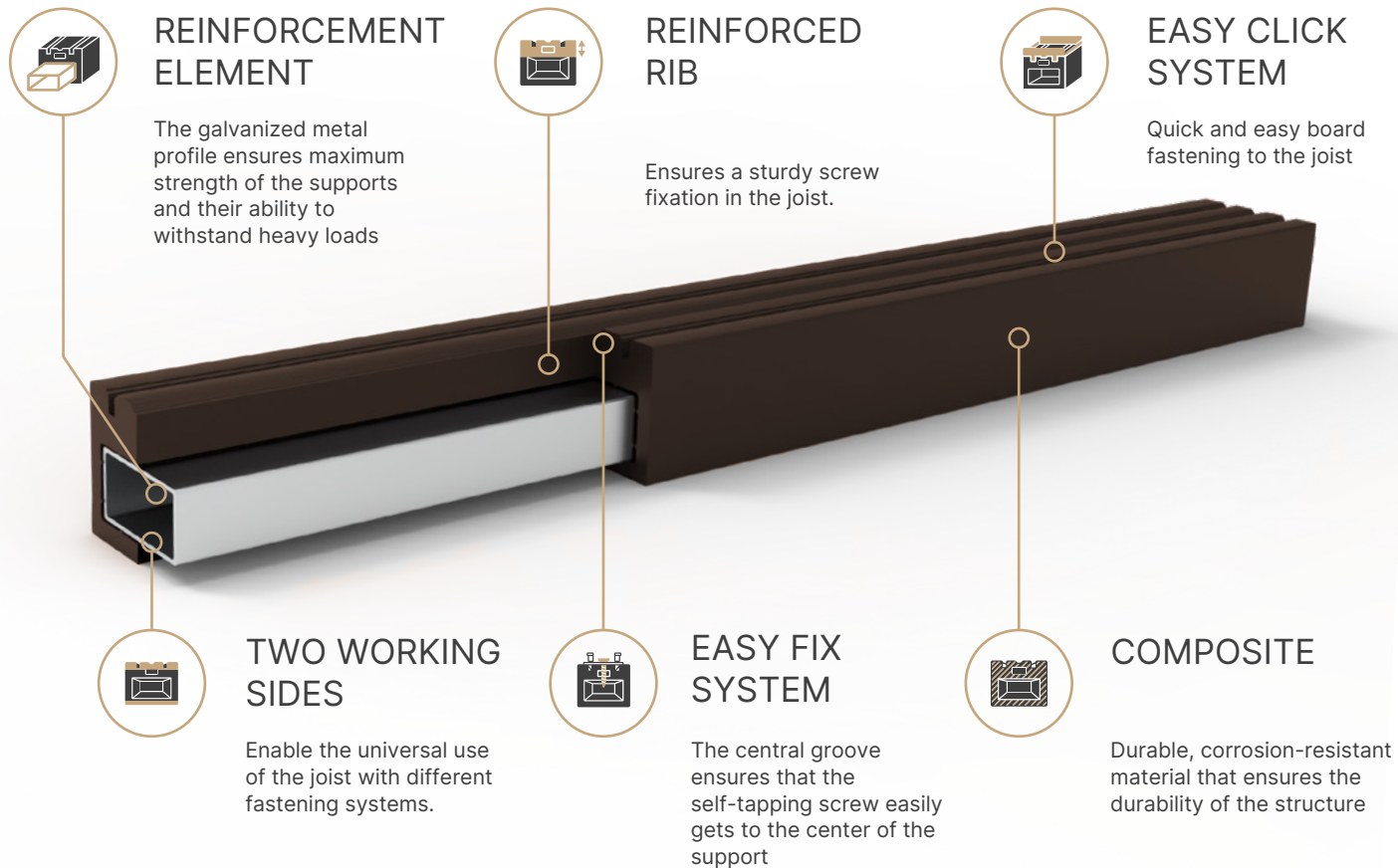

22

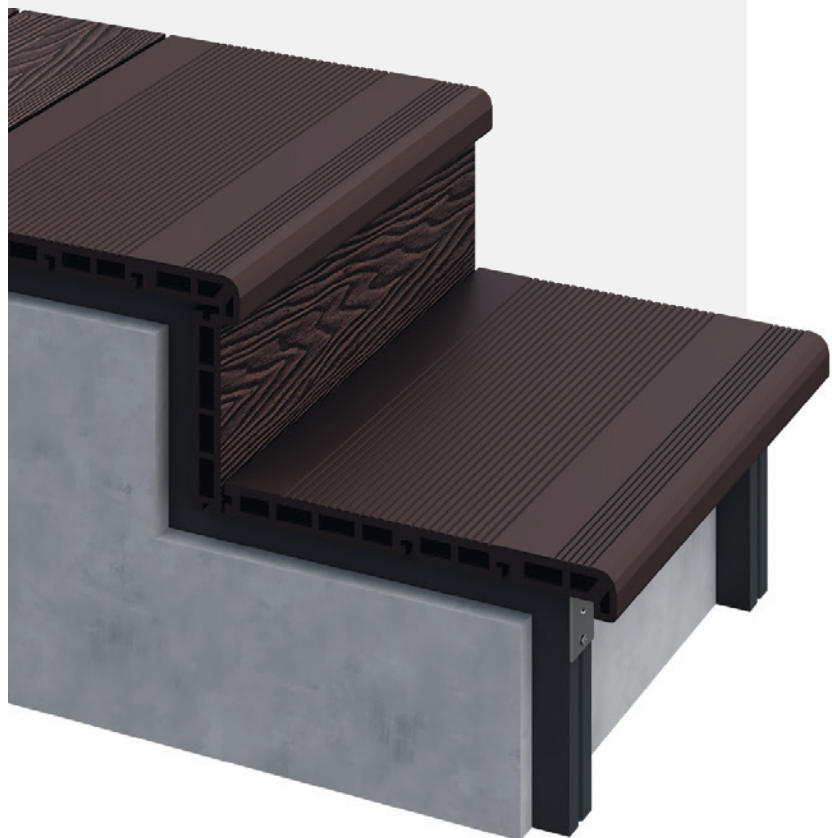

BRUGGAN ELEGANT STEP

The Elegant step has a width of 320 mm. It is ideal to be used together with the Bruggan Elegant decking board to create a beautiful and functional terrace.

Thanks to the overhang of the step, you can install an LED strip for lighting, adding style and safety in the dark.

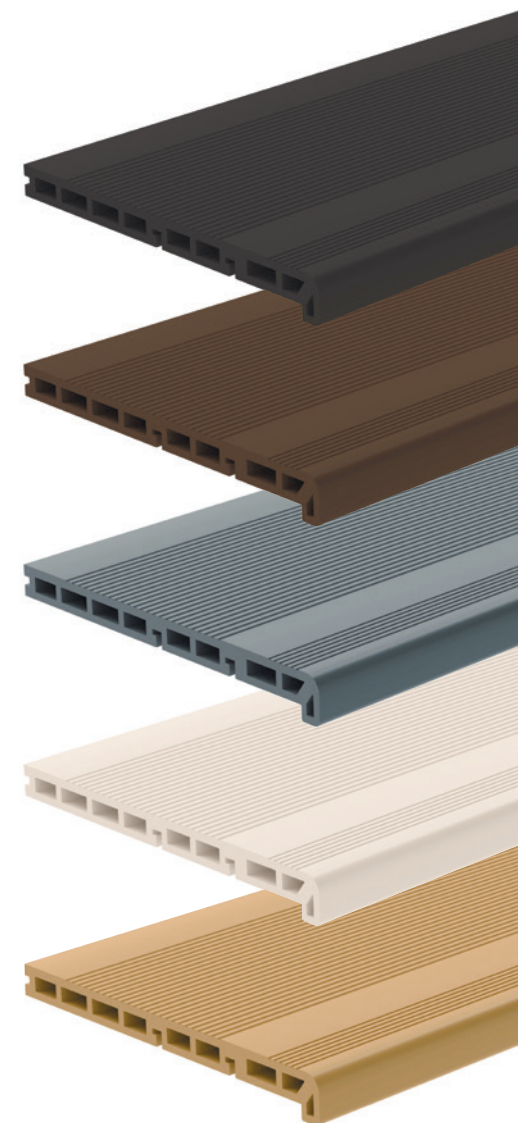
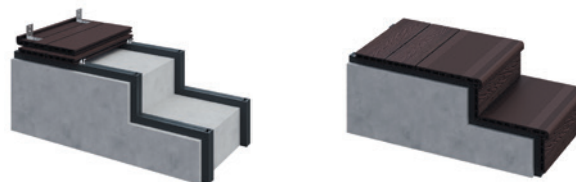

PARAMETERS

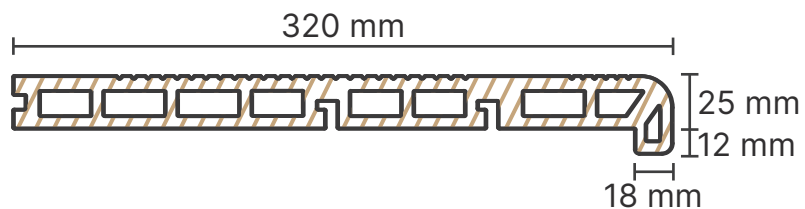

This step also makes installation easier and adds the finishing touch to your terrace.

SPINDLE SUPPORTS

STANDART SYSTEM



30-45MM



45-70MM



70-120MM



120-220MM



220-320MM



STANDART SYSTEM



WEDGE SUPPORTS

RAPTOR SYSTEM



S 15-35MM



M 35-65MM



L 65-95MM



XL 95-125MM



ADDITIONAL PEDESTAL

RAPTOR SYSTEM





25

AREAS AROUND THE SWIMMING POOLS

MATERIAL

Bruggan Multicolor

COLOR

Grey

OBJECT

Private home

SURFACE

470 M2



26

FIELD OF APPLICATION



TERRACES

MATERIAL

Bruggan Multicolor

COLOR

Grey

OBJECT

Private home

SURFACE

380 M2

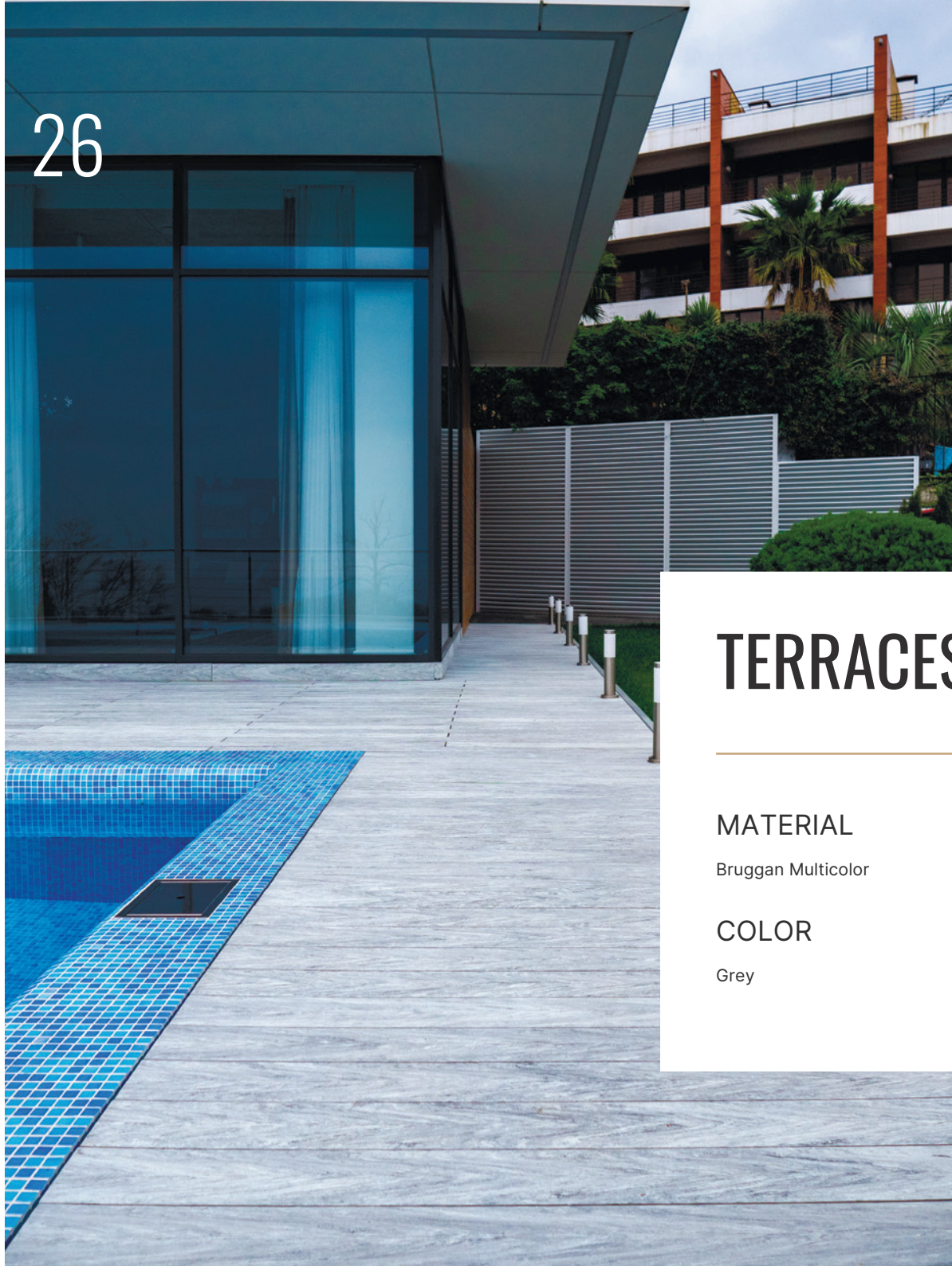





AREAS AROUND THE SWIMMING POOLS

MATERIAL

Bruggan Elegant Light 3D

COLOR

Wine Brown

OBJECT

Hotel of Riverwood Relax Park

SURFACE

1370 M2





TERRACES AND WALKAWAYS

MATERIAL

Bruggan Multicolor

COLOR

Cedar

OBJECT

Private home

SURFACE

235 M2







ROOF TERRACE

MATERIAL

Bruggan Multicolor

OBJECT

Royal Tower

COLOR

Bruggan Multicolor

SURFACE

820 M2



COTTAGE AND HOTELCOMPLEX

MATERIAL

Bruggan Multicolor

COLOR

Grey

OBJECT

Family Club 55

SURFACE

430 M2





36

FIELD OF APPLICATION



RESTAURANT AND HOTELCOMPLEX

MATERIAL

Bruggan Multicolor

COLOR

Grey

OBJECT

Nasha Dacha

SURFACE

700 M2

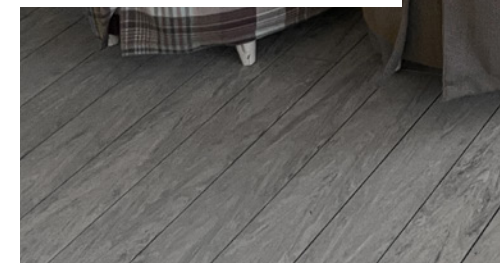





THINK GREEN

The Bruggan company is committed to the environment.

This shared value unites our team and inspires us to create innovative materials.

At the same time, we vehemently oppose deforestation and do everything in our power not only to preserve but also to increase forest areas.

We advocate for a world where people are surrounded by the beauty and comfort of natural wood, while preserving the planet's ecology for the future of our children.

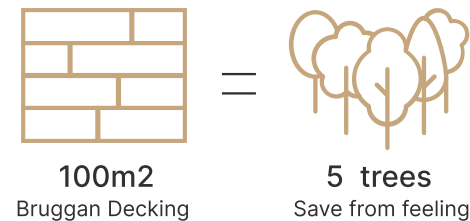

By choosing Bruggan products, our customers help save around 3000 trees annually, making a positive impact on our planet.

Join us, people who care about the future of our planet!



CONTACTS

Bruggan



www.woodplast.com

